

Licence d'éducation SolidWorks
A titre éducatif uniquement

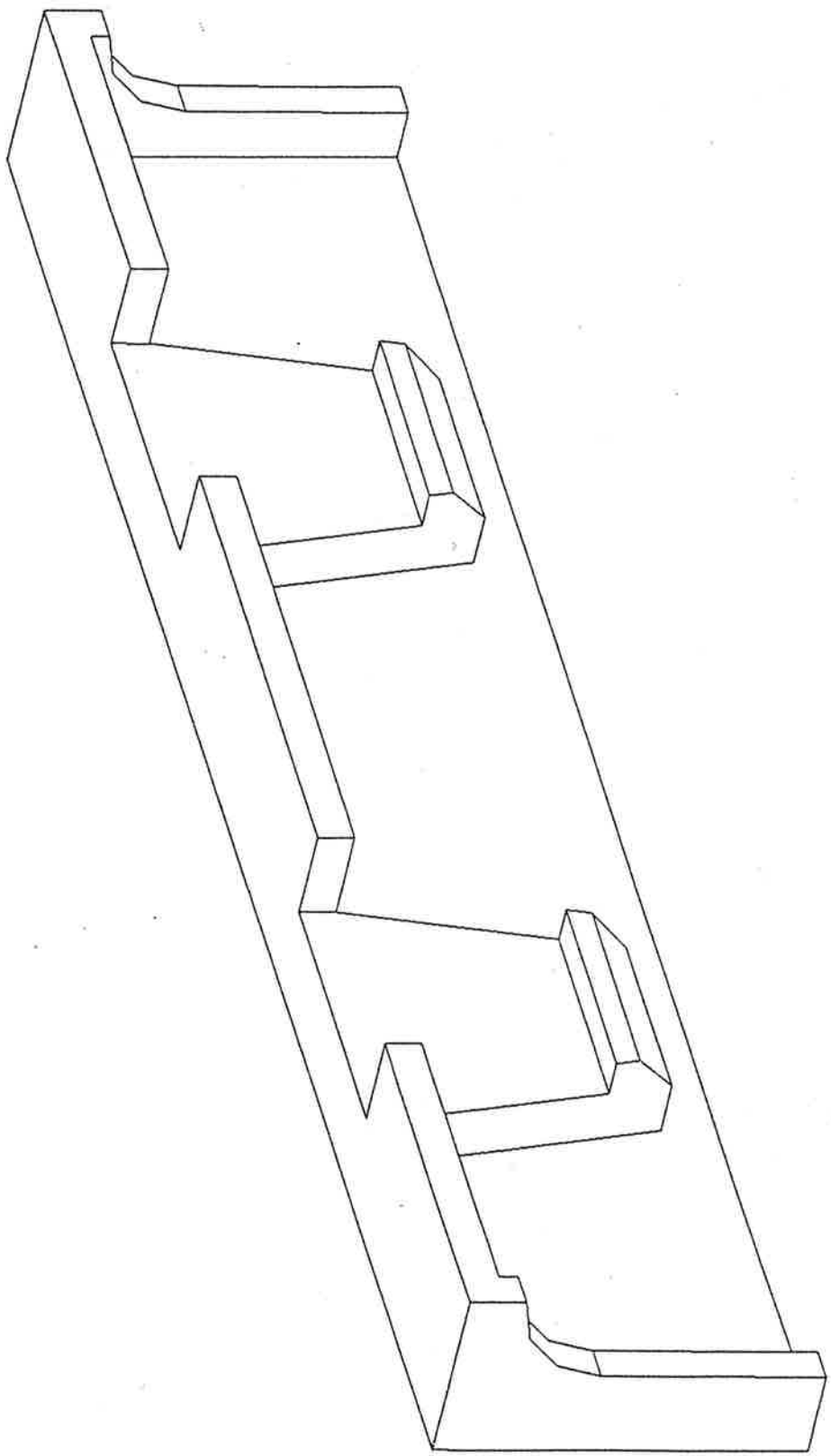

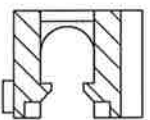

COUPE B-B

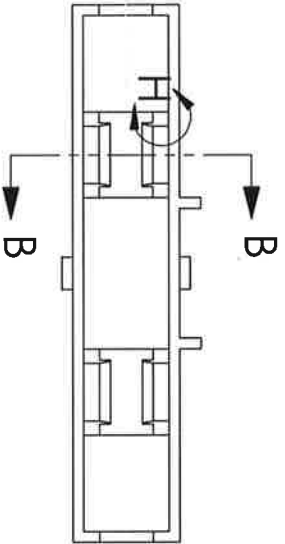
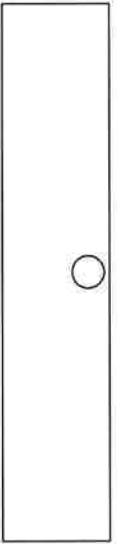
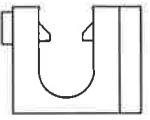
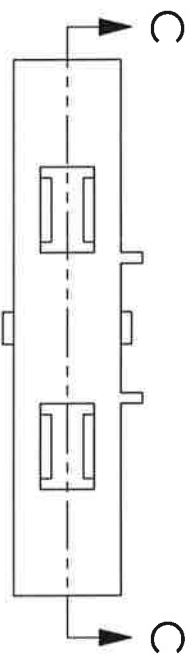
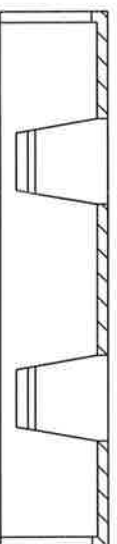

COUPE C-C

