

DIVERS-FZ

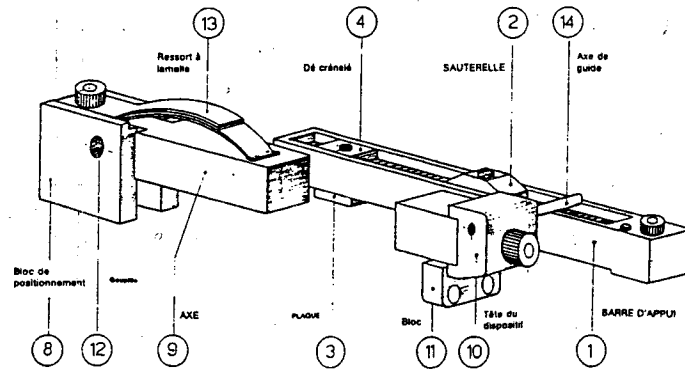

D-M-E

LL-051 / LL-101 / LL-201

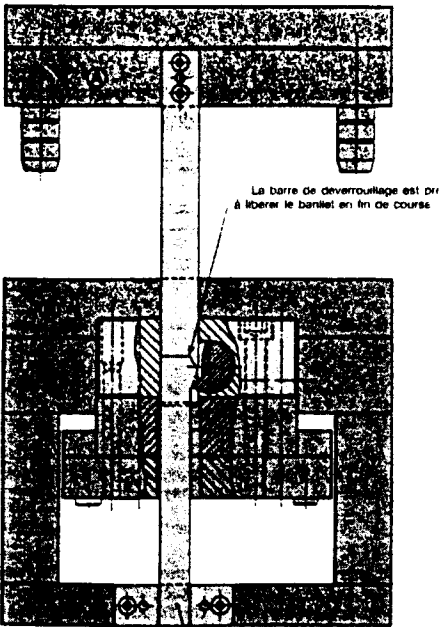
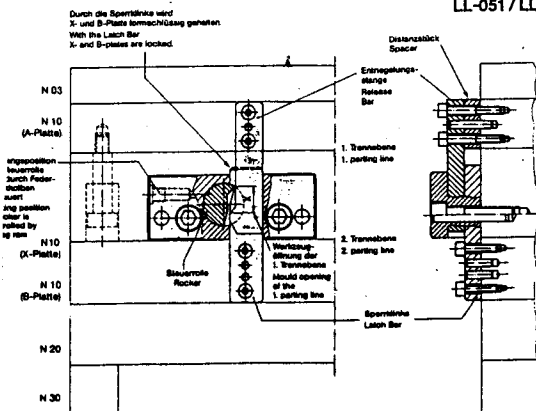

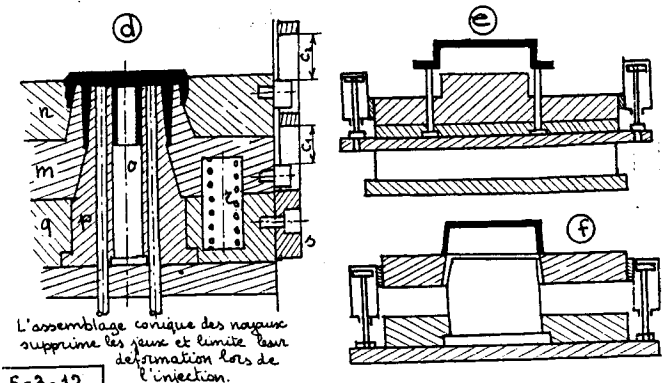
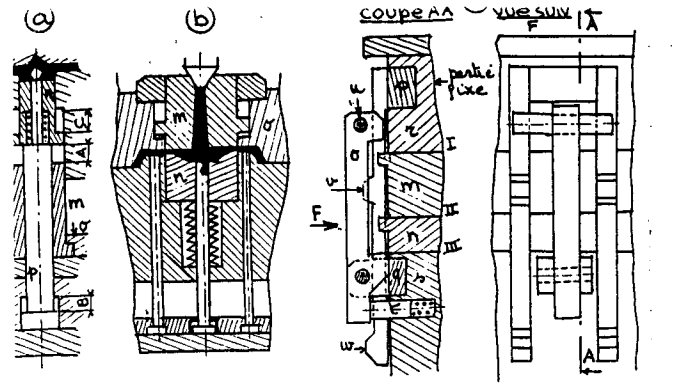

L'assemblage conique des noyaux
supprime les jeux et limite leur
déformation lors de
l'injection.

5-3-12

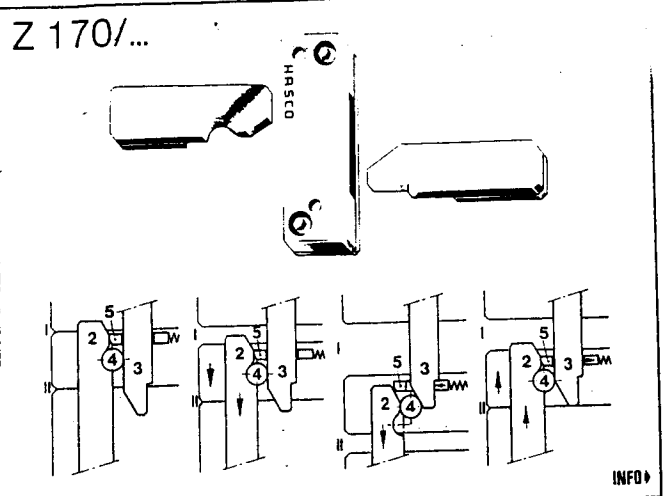

INFO

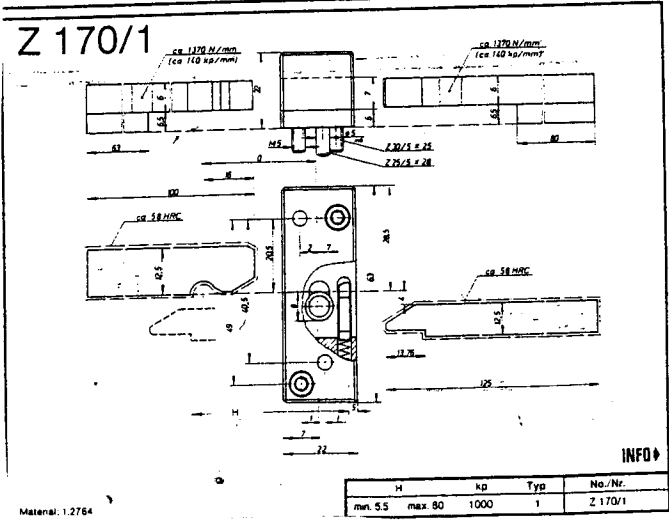

INFO

H	kp	Typ	No./Nr.
min. 55	max. 80	1000	1
			Z 170/1

Matériau: 1.2764

DIVERS FG