

Atline  
P

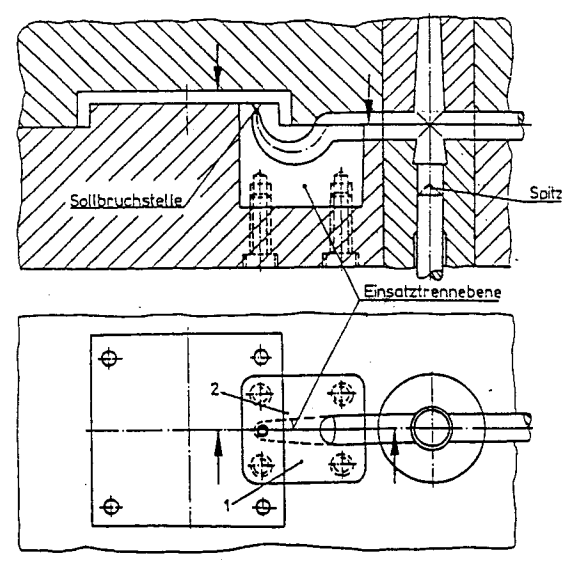

AL2-F P-CAS

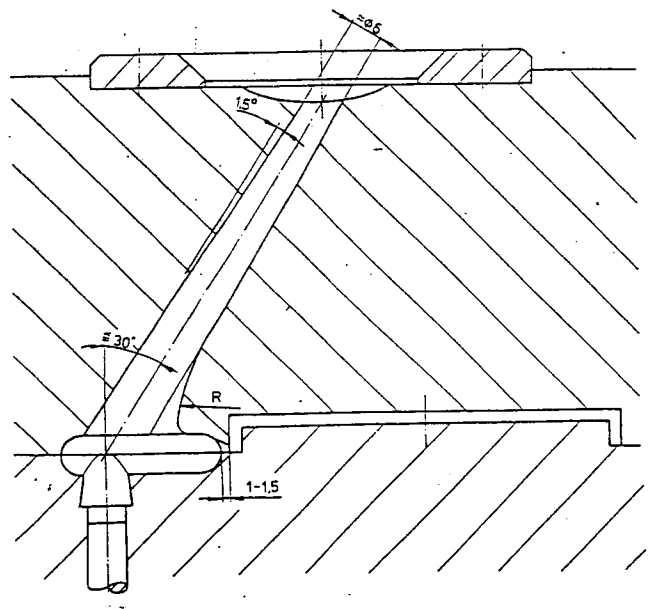
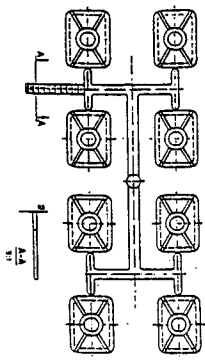

Sans piège à goutte froide

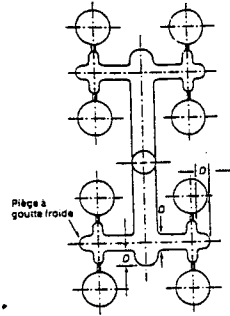
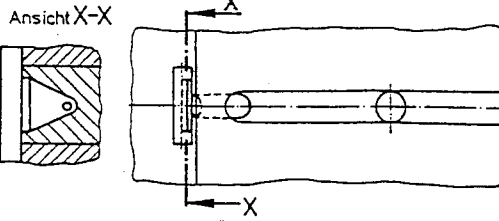
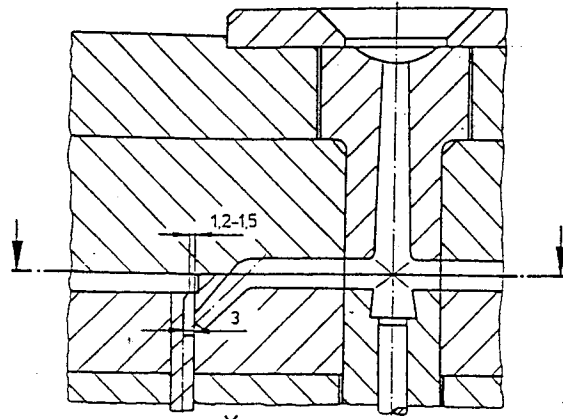

Avec piège à goutte froide

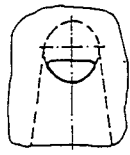
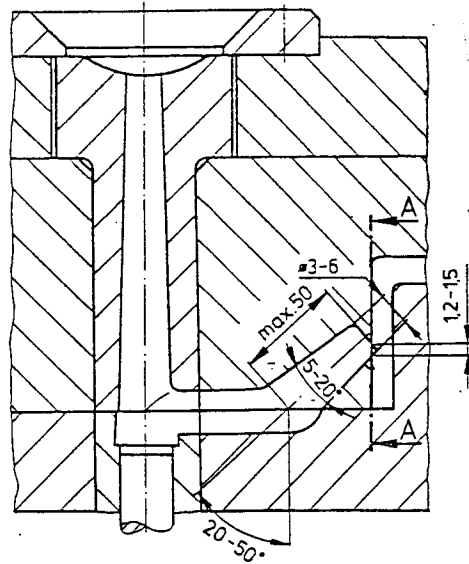

Ansiicht A-A  
M=2:1

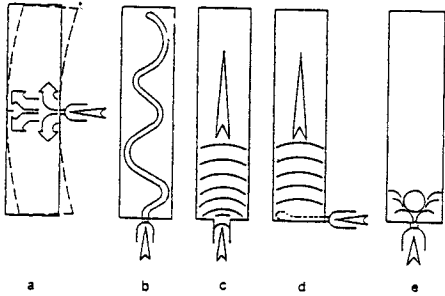

Handwritten notes: "2", "A-A", "us"

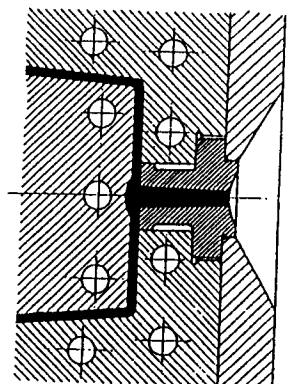
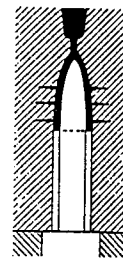
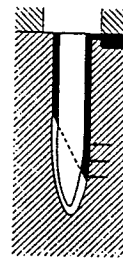
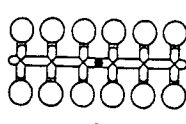
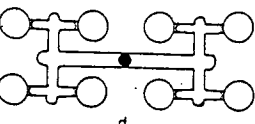
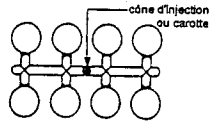
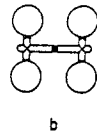
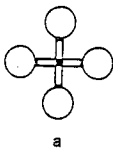
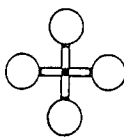
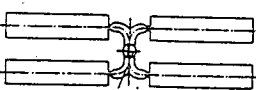
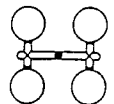
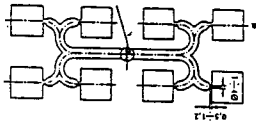
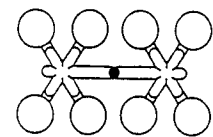
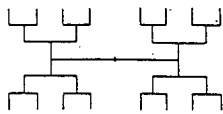
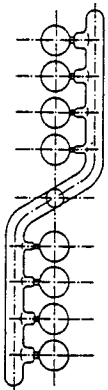

AL-FL PCAS

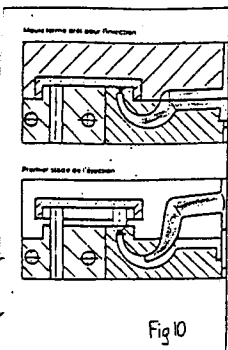
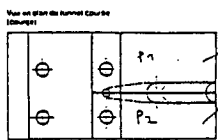
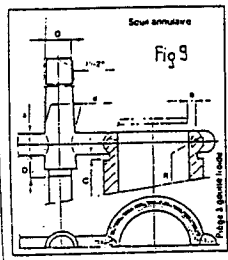

Fig 10

ALIMENTATION DIRECTE DES EMPREINTES



APPUI CONIQUE

APPUI CONIQUE+PLAN

Fig 20

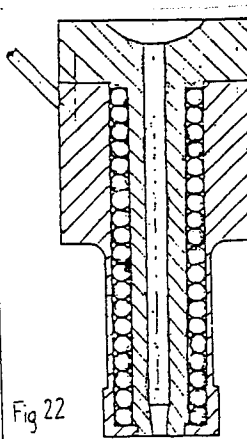
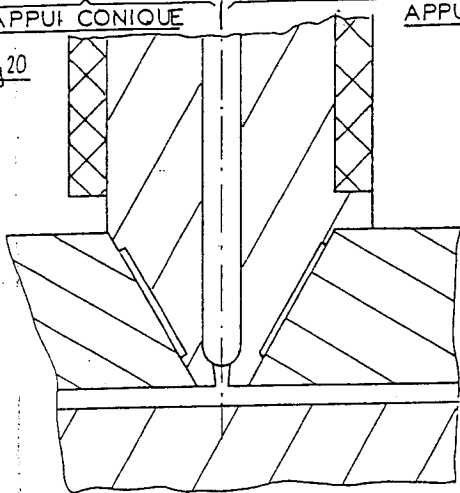

Fig 22

Buse chauffante

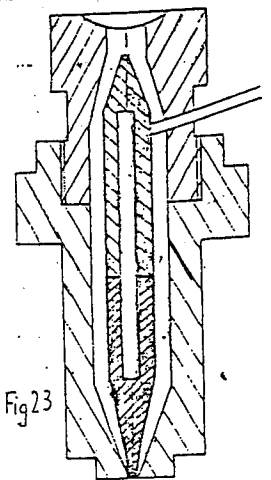
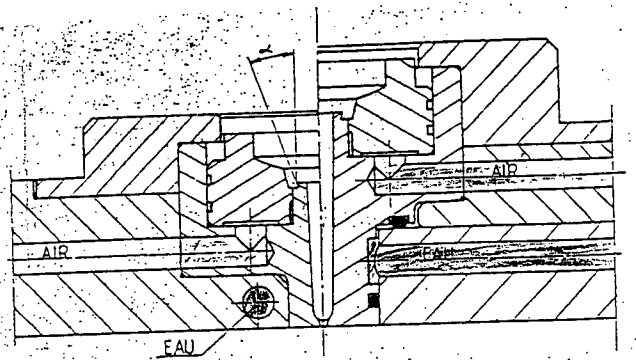

Fig 23

Buse à cartouche chauffante



APPUI PLAN + ANTICHAMBRE

Fig 21

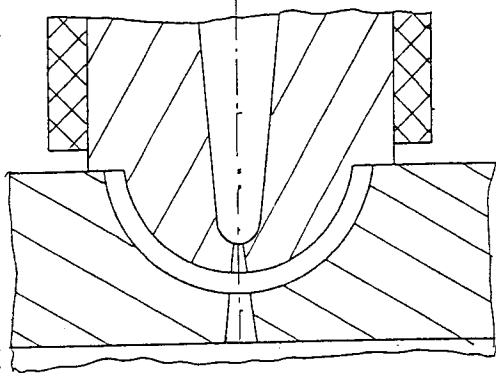

85

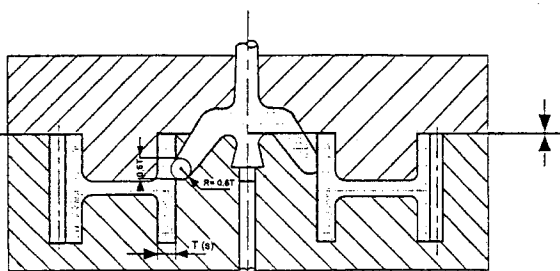
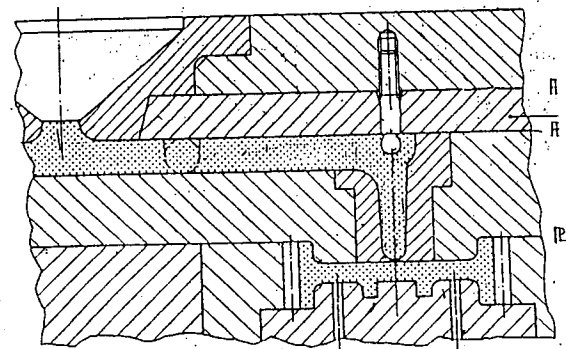

Injection en sous marin sphérique avec calotte circulaire pour matériaux visqueux.

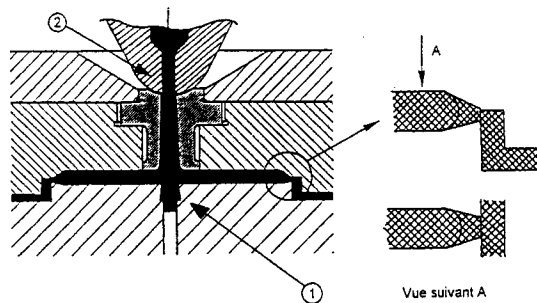

Vue suivant A

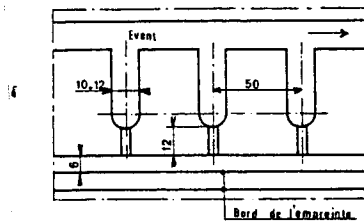
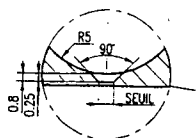
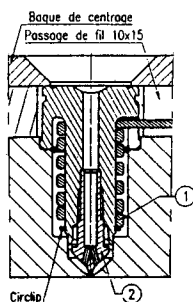
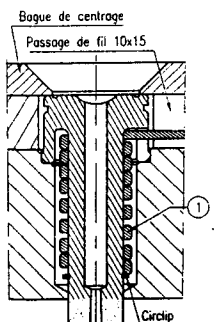

Bord de laminaison

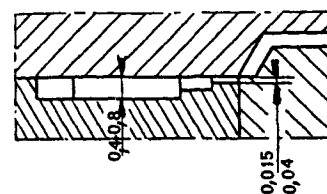

D-M-E

A2-F3  
MACHINING



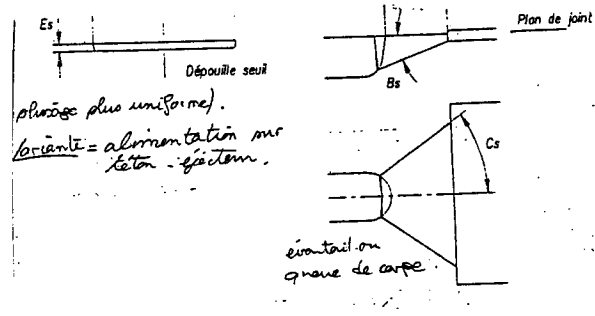
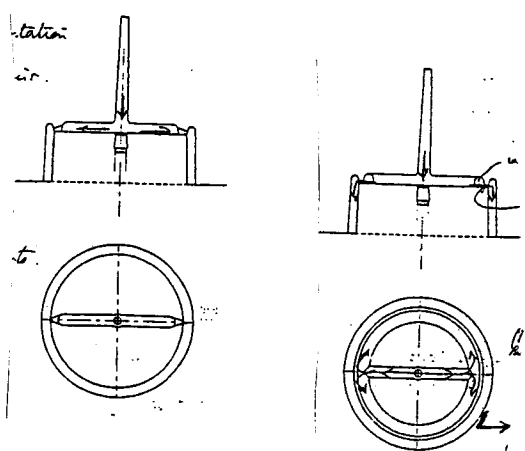
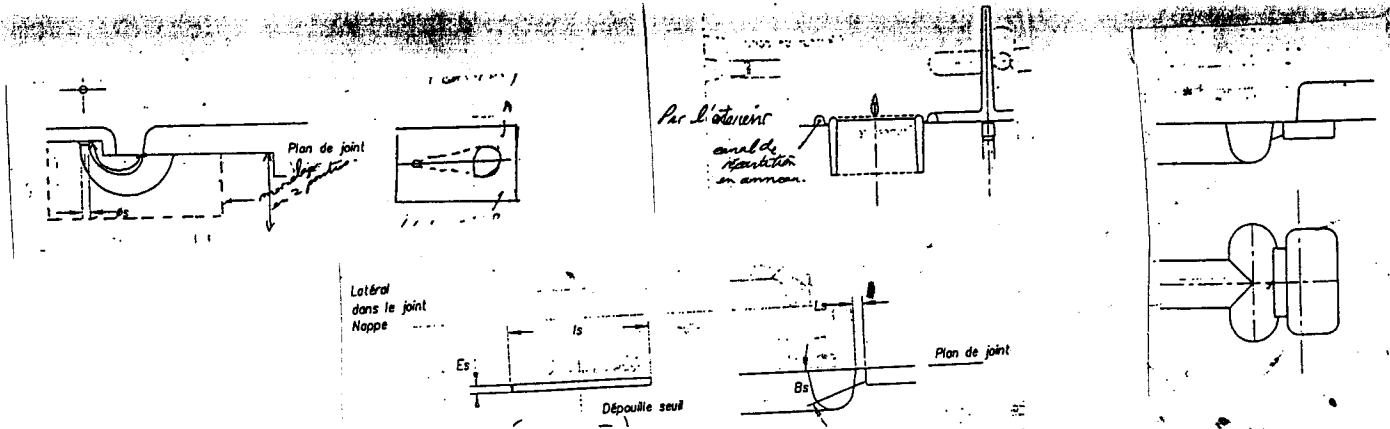

ALIMENT  
LAC

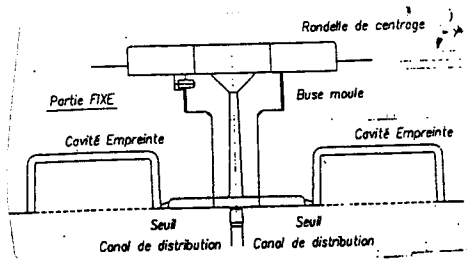
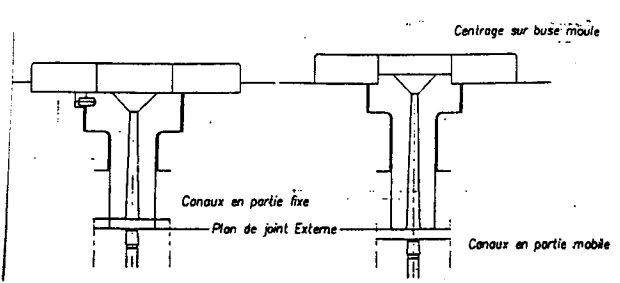
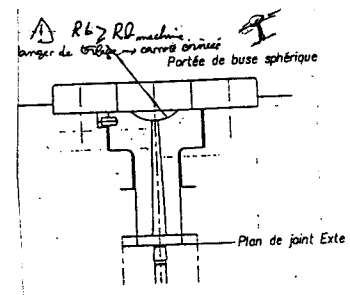
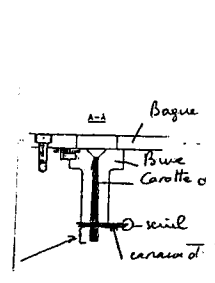
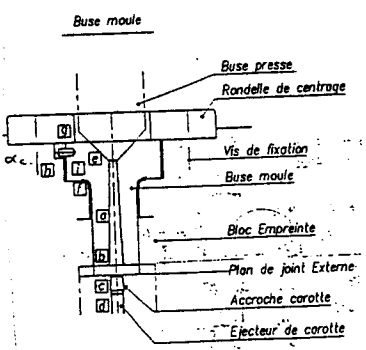
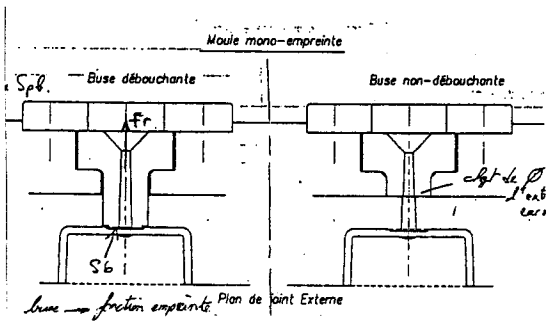
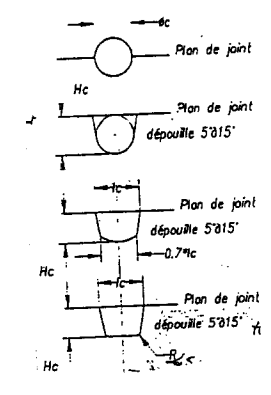

AL-F5  
LAC

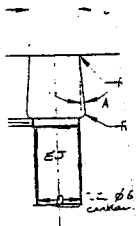
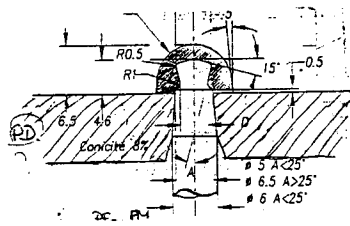
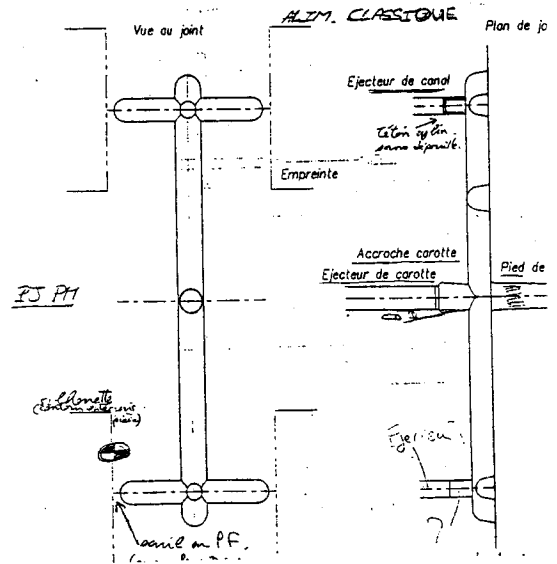
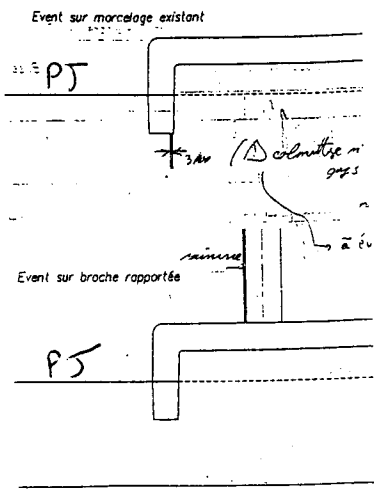
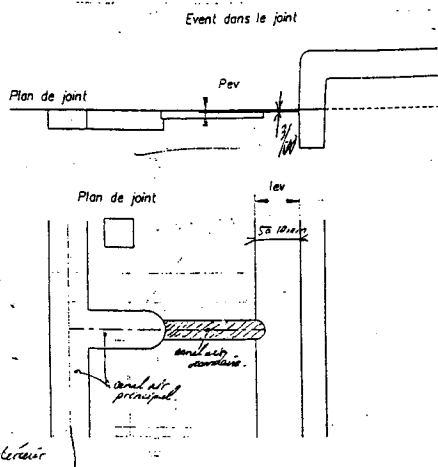

ATION

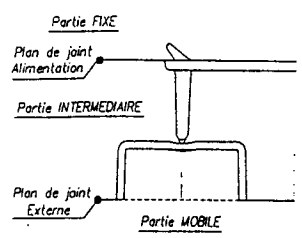
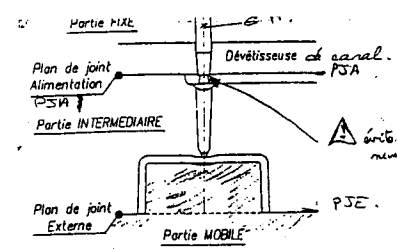
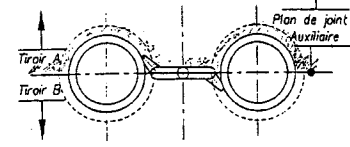
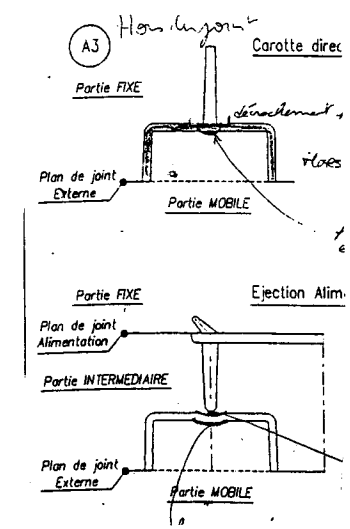
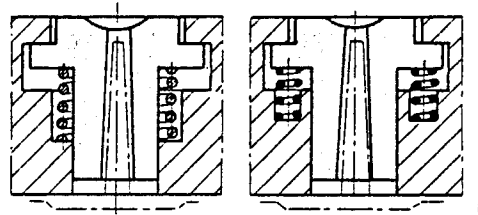
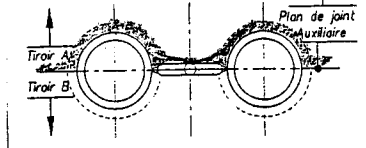
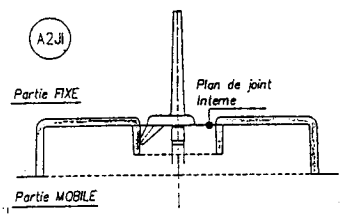
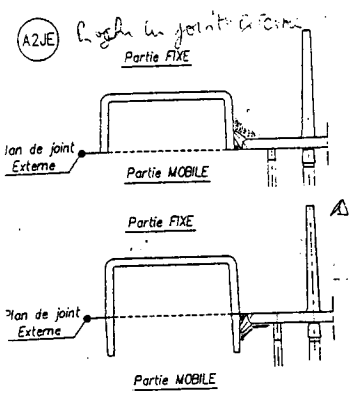
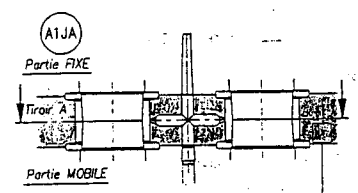
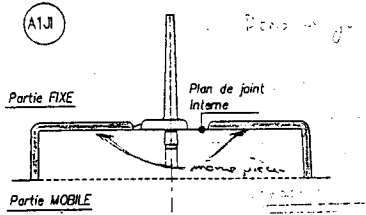
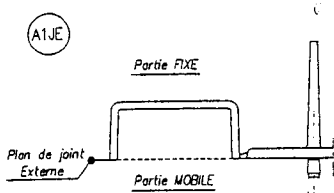

AL-FG  
LAC

• Buse ouverte

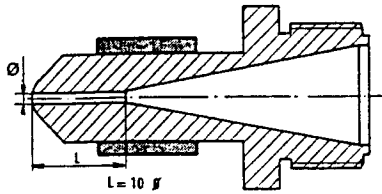

• Buse à aiguille

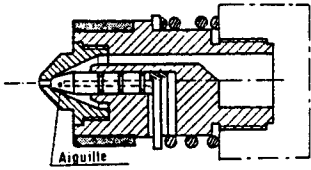

L'aiguille joue le rôle d'obturateur.

• Buse à torpille

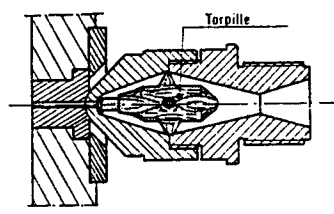

La torpille joue le rôle d'obturateur.

Alésage préparé dans la plaque :

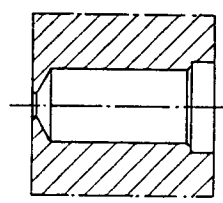

Nez conventionnel à équiper :

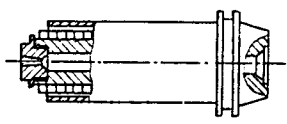

Équipements pour équiper le nez :

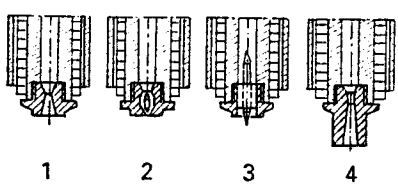

• HASCO

La buse standard est placée dans un élément de base monté dans la plaque porte-buse.

Seuils HASCO :

- 1 : nez pointeau
- 2 : nez carotte longue
- 3 : nez carotte courte

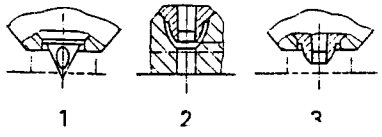

• Buse à seuil capillaire

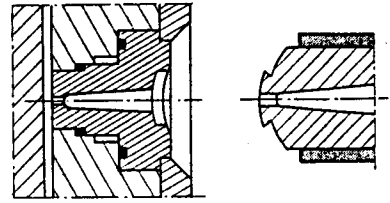

• Buse plongeante

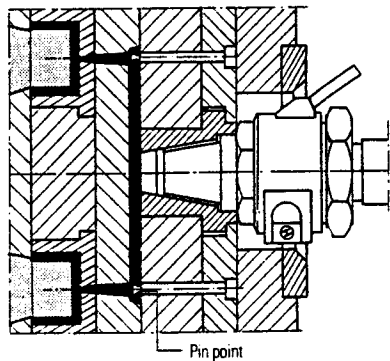

Suppression de la carotte dans un moule d'injection "pin-point".  
L'automatisme de la presse est facilité.

Élément de base à placer dans la plaque :

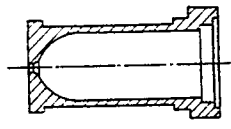

Buse standard mise en place :

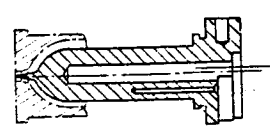

À éviter

Conseillé

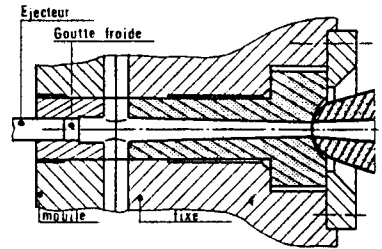
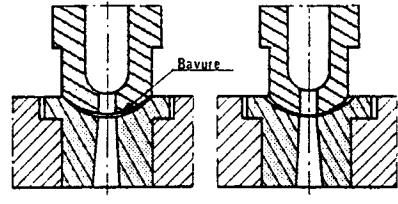

• Buse plongeante - 40

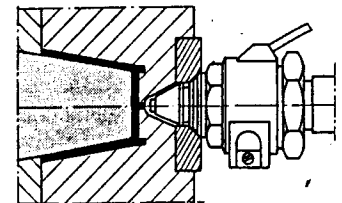

Moulage sous cadences élevées.  
Point d'injection capillaire.

• Contact plan

• Contact conique

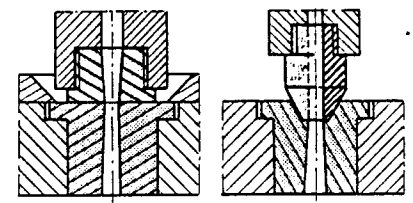

• Contact goutte de suif

• Contact sphérique

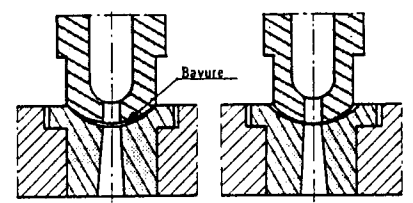

• Buse plongeante

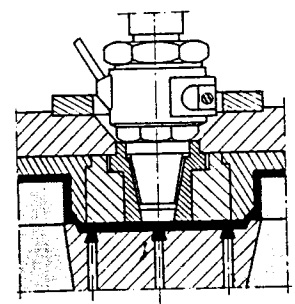

Suppression de la carotte.  
Pas de déchets.

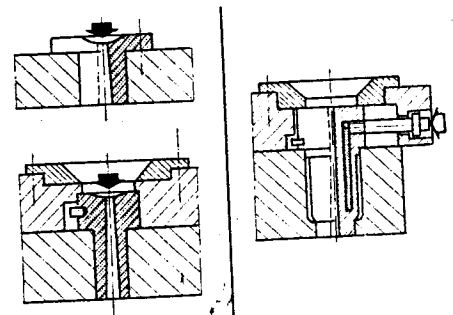

AL-F7  
MENOTECH

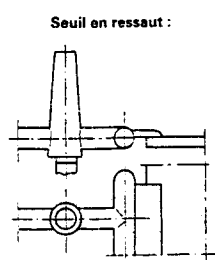
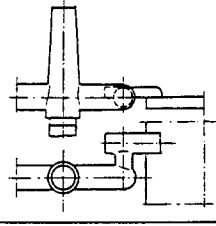
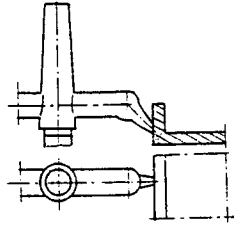
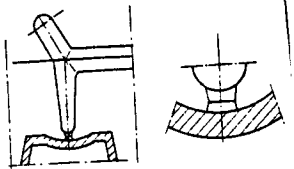
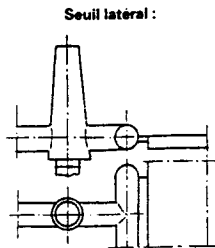
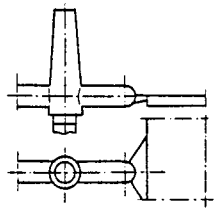
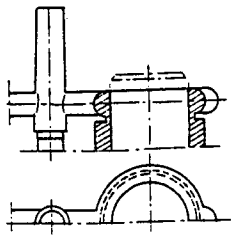

Moule fermé prêt pour l'injection :

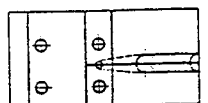
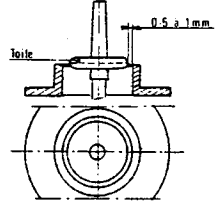
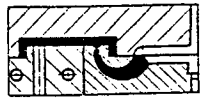

Premier stade de l'éjection :

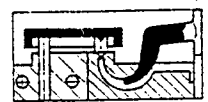

Canal cintré pendant la dernière phase de l'éjection :

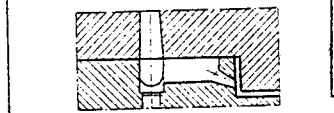
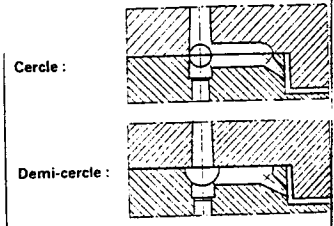
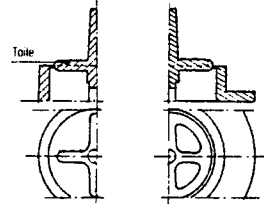
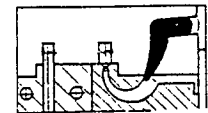

• Répartition pour 16 empreintes

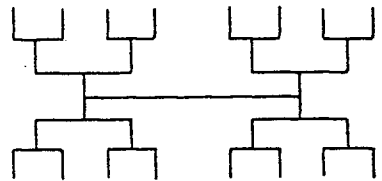
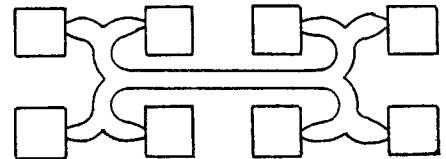

• Avec goutte froide

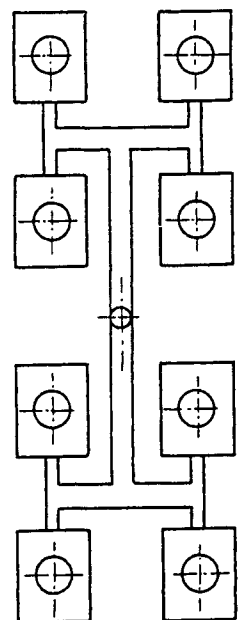
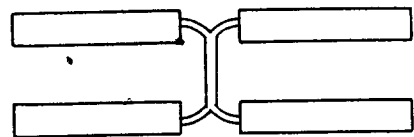
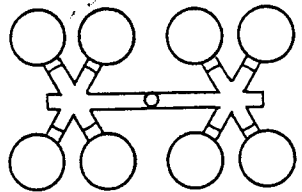
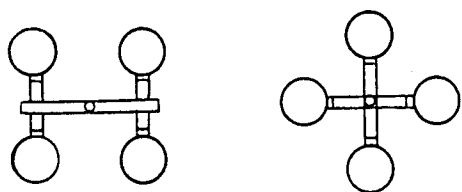
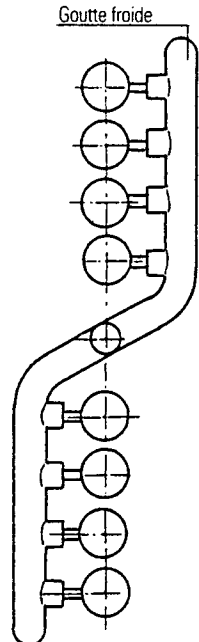
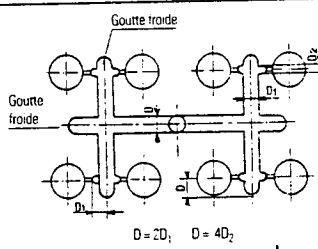

AL-F8  
MEMOTECH