

MT

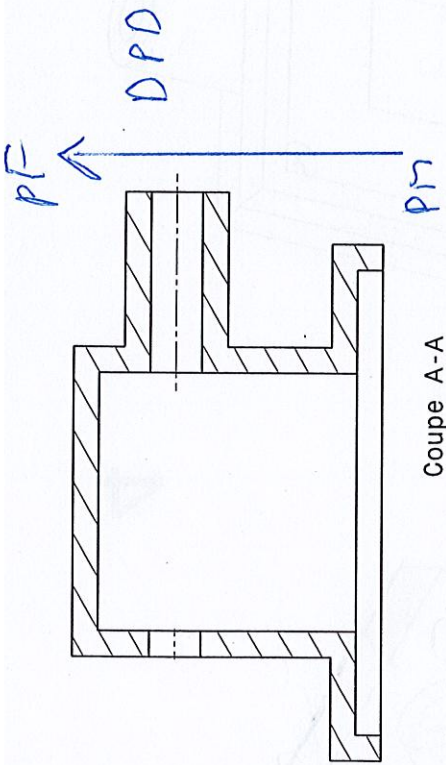

Coupe A-A

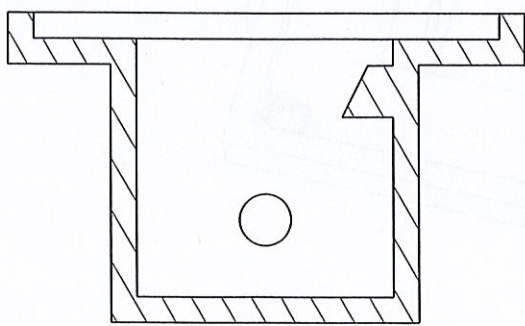
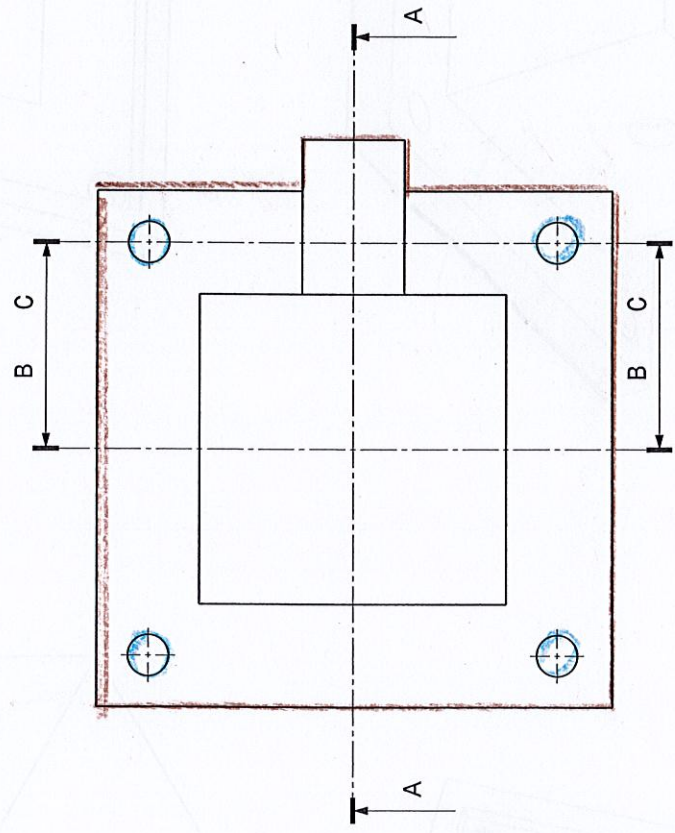

Coupe B-B

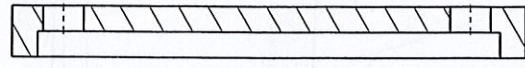

Coupe C-C

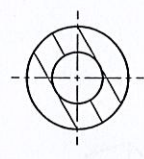

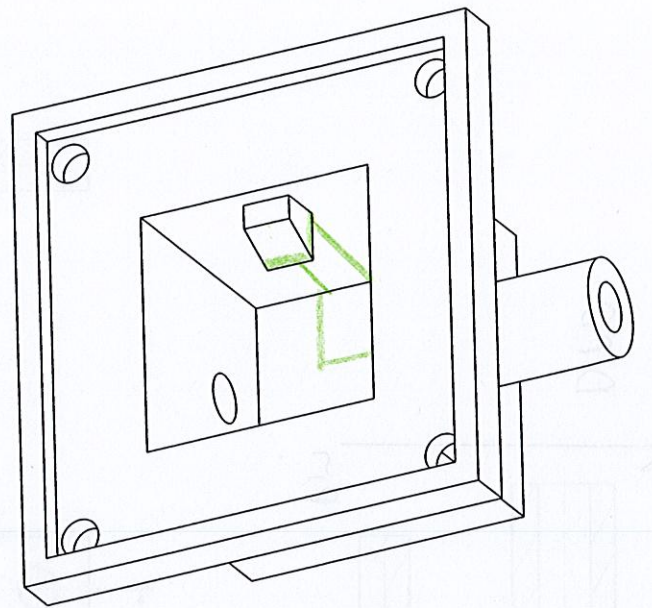
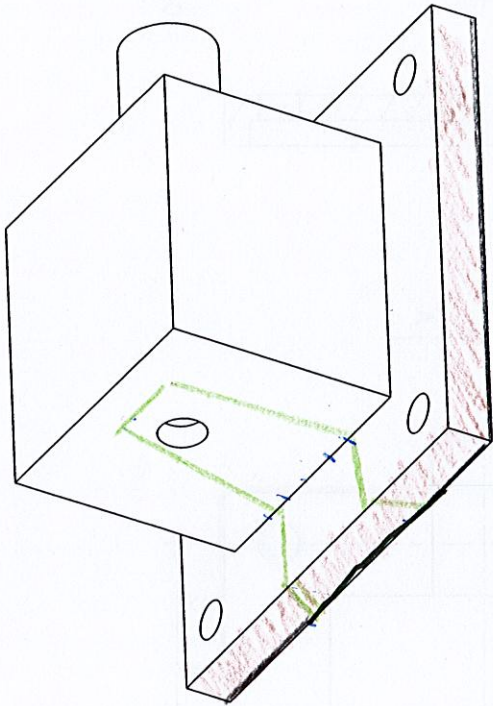

4

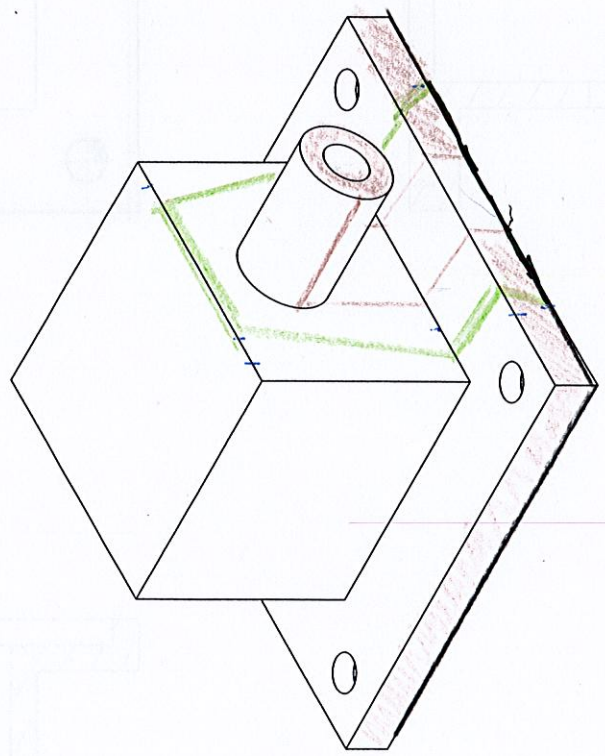
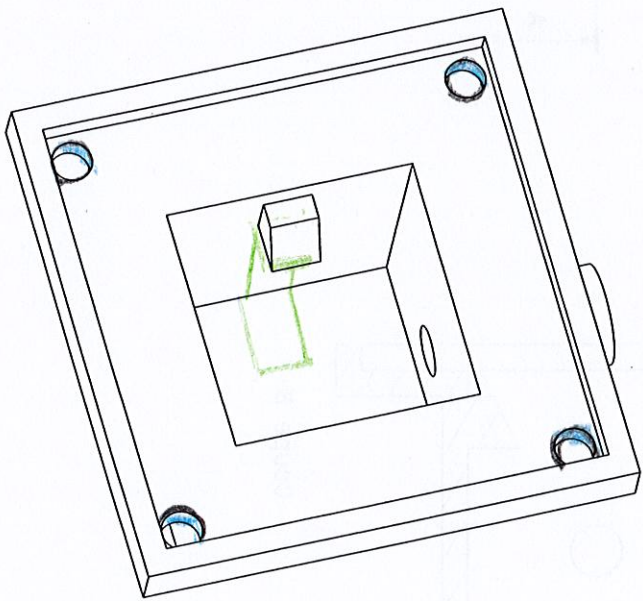

HT



# Grofflet

MT

1 - Injection matières 1 et 2

+ Pièces injectées

2 - Mouvement Vent Mignon Tourne

+ moule ouvert partiellement

3 - Éjection pièce finie (A droite)

+ Pièce éjectée

4 - Mouvement Vent Mignon Tourne

+ Crochet 25 a "sortir du borse" Avec gonpille 26

5 - Mouvement Vent Mignon

+ moule ouvert totalement

6 - Rotation Mignon à 180°

+ Mignon tournée

7 - Fermeture moule

+ moule fermé



PCCOFI 22-11-18

Prénom	Nom	4GMP C1	4GMP C2
Oumaima	AHOZI	EP201	4GMP C1
Suzanne	BAR	EP201	4GMP C1
Jules	BOISSE	EP201	4GMP C1
Mathieu	BRAYMAND	EP201	4GMP C1
Louis	CAMBOULIVES	EP201	4GMP C1
Come	MARTIN	EP201	4GMP C1
Manar	RAMRAM	EP201	4GMP C1
Hugo	CHARLES	EP202	4GMP C1
Corentin	DOMENEGHETTY	EP202	4GMP C1
Louis	DUJARDIN	EP202	4GMP C1
Oumaima	GOUMIRI	EP202	4GMP C1
Loan	GRIMM	EP202	4GMP C1
Chloe	GUERIN	EP202	4GMP C1
Antoine	JEANDIN	EP202	4GMP C1
Margherita	BOTTENE	EP203	4GMP C1
Vinciane	CROZIER	EP203	4GMP C1
Loic	DUMONT	EP203	4GMP C1
Jean-Guy	LE GAC DE LANSALUT	EP203	4GMP C1
Noel	LECOINTE	EP203	4GMP C1
Guoliang	LI	EP203	4GMP C1
Mohamed	SILOUD	EP203	4GMP C1
Hantuo	CHEN	EP204	4GMP C2
Dang-Huy	LEU	EP204	4GMP C2
Tiphaine	MALGRANGE	EP204	4GMP C2
Emna	MASGHOUNI	EP204	4GMP C2
Manal	MOKRINI	EP204	4GMP C2
Amaury	SIMONPIERI	EP204	4GMP C2
Marie	NEYRET	EP205	4GMP C2
Remi	ORSET	EP205	4GMP C2
Chihab Eddine	OUCHANNOUK	EP205	4GMP C2
Coline	PETETIN	EP205	4GMP C2
Paul	PETIT-TALAMON	EP205	4GMP C2
Firmin	STRAPPAZZON	EP205	4GMP C2
Julie	VIOLLET	EP205	4GMP C2
Clara	MAHIET	EP206	4GMP C2
Stacy	PATTI	EP206	4GMP C2
Michael	PREIONI	EP206	4GMP C2
Thomas	REGINA	EP206	4GMP C2
Benjamin	RISSON	EP206	4GMP C2
Thomas	STOREY	EP206	4GMP C2