

OSTER
Guillaume

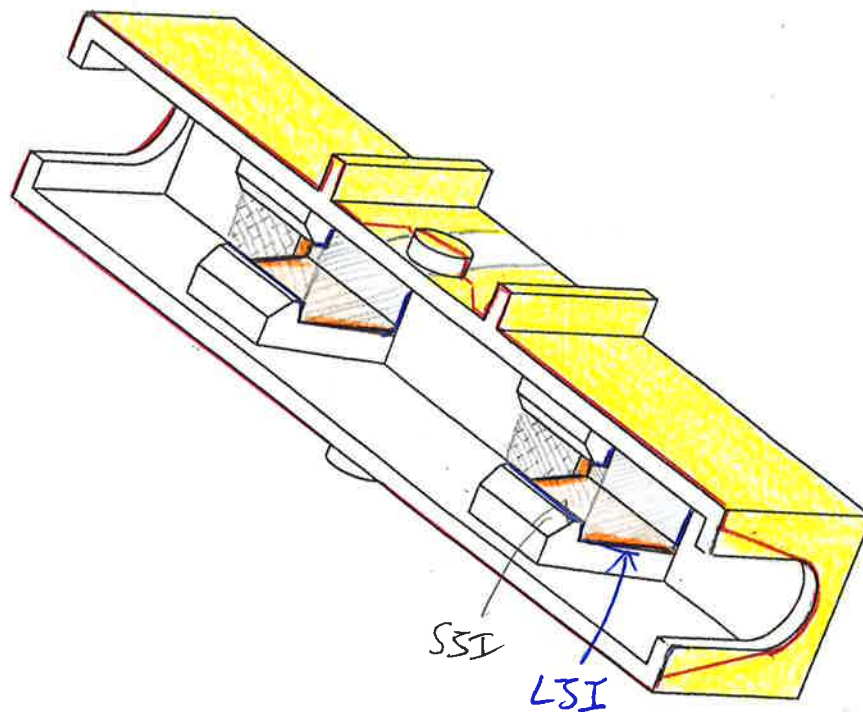

Licence d'éducation SolidWorks
A titre éducatif uniquement

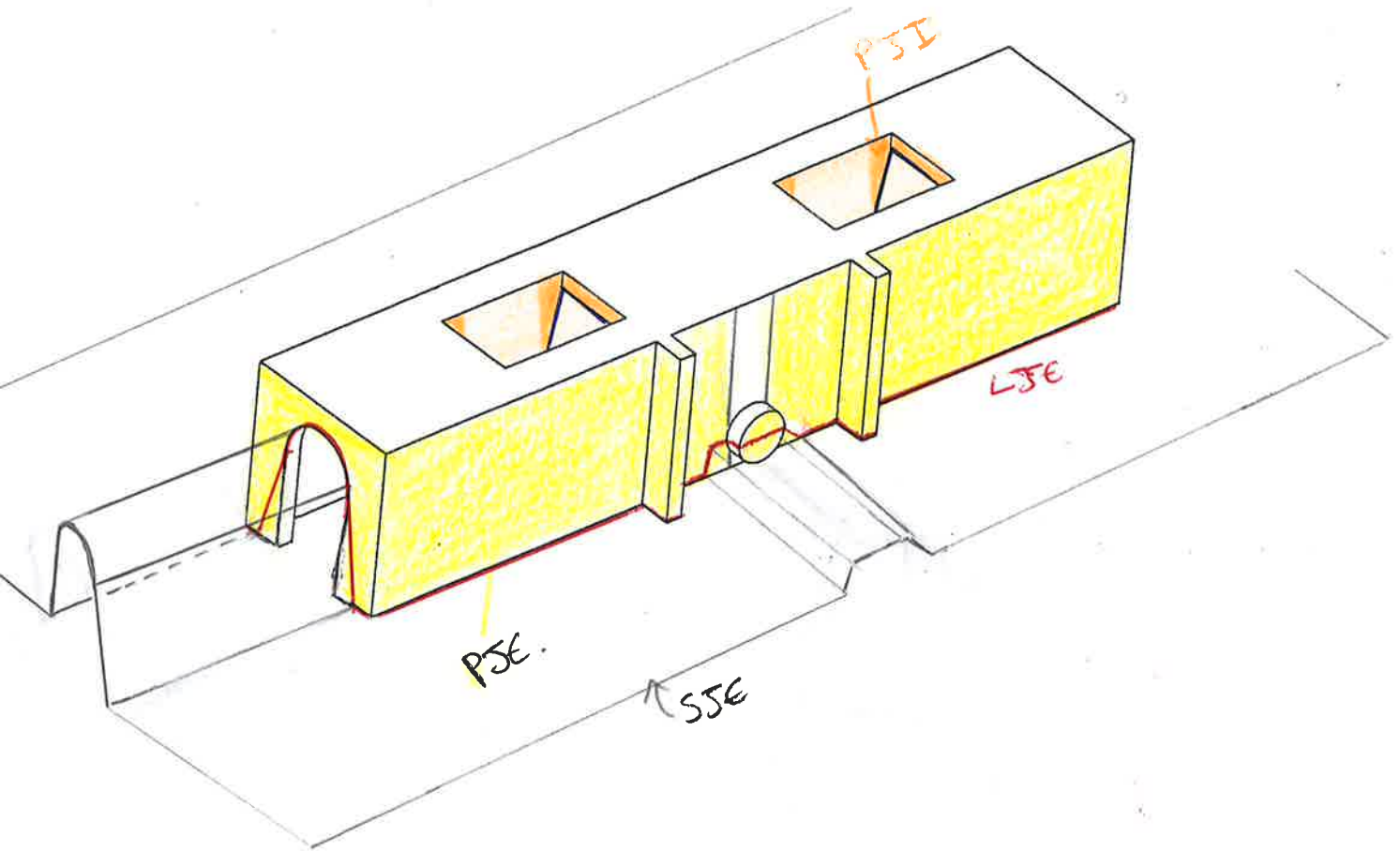

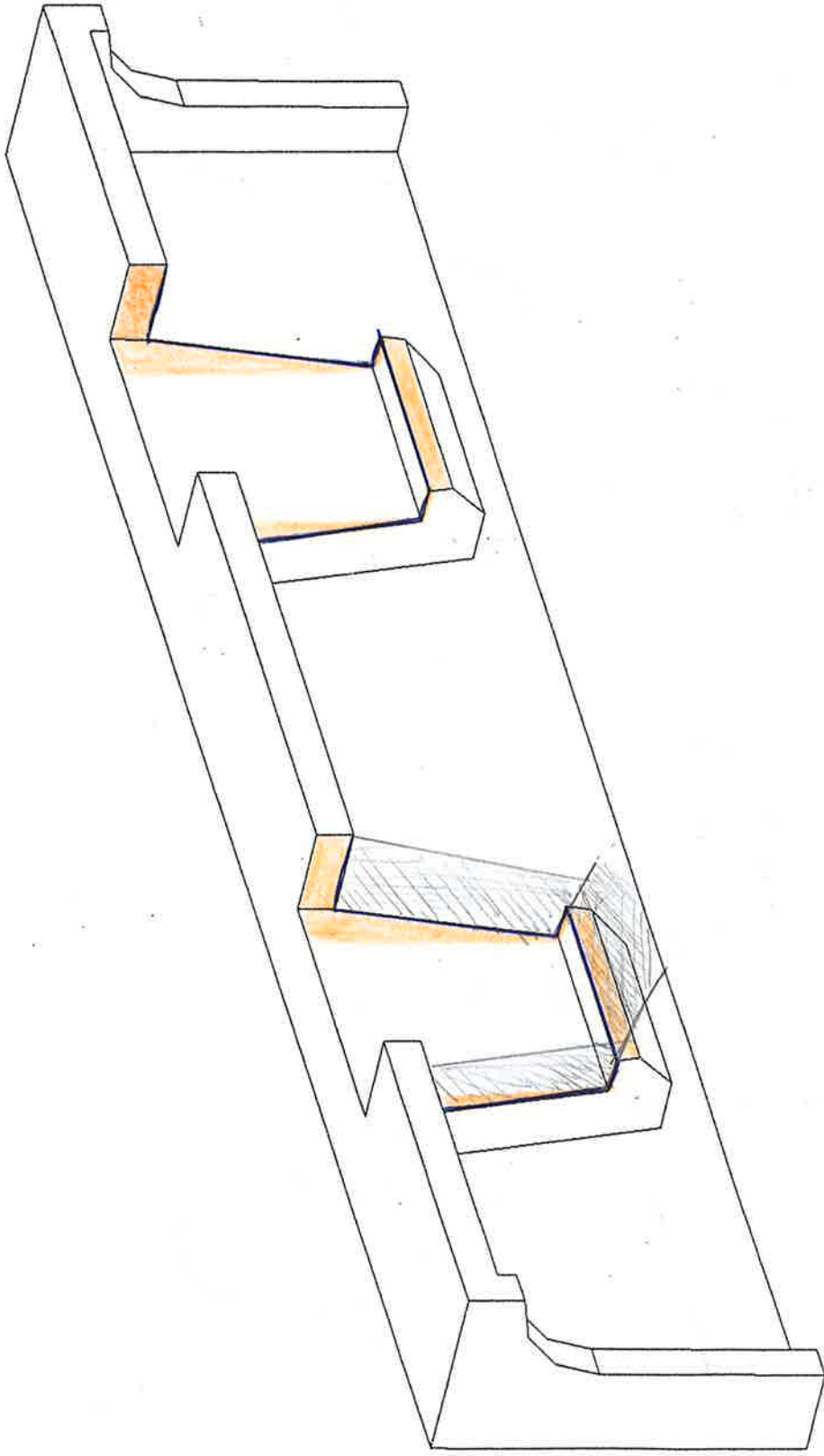
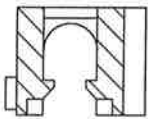
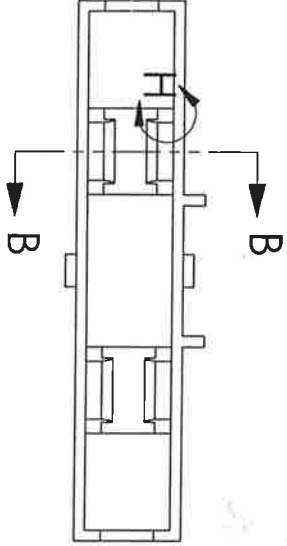
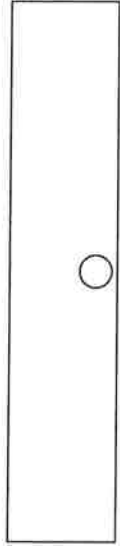
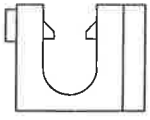

COUPE B-B

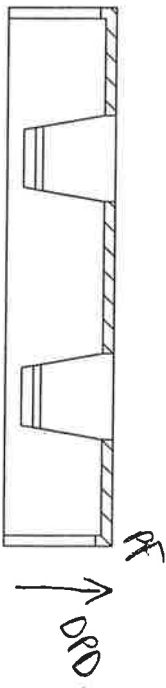

COUPE C-C

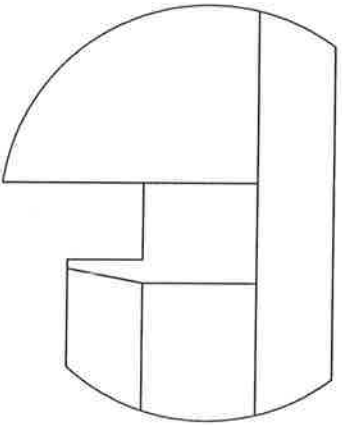
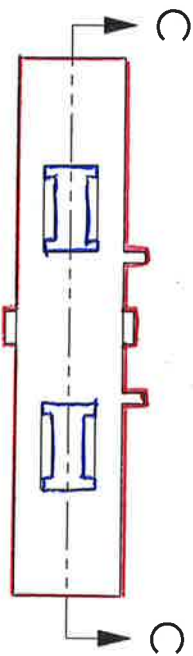

DETAIL H
E

ECHELLE 14 : 1